

Cristal fijo / Single panel / Verre fixe / Vidro fixo / Vetro fisso

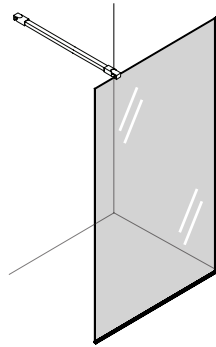

Acabados / Finishes / Finition / Acabamento / Finitura



CR
Cromado
Chromed
Chromé
Cromado
Cromato



BM
Negro mate
Black matt
Noir mat
Preto mate
Nero opaco



MG
Metal gun
Metal gun
Metal gun
Metal gun
Metal gun



NB
Níquel cepillado
Nickel brushed
Nickel brossé
Níquel escovado
Nichel spazzolato



BG
Oro cepillado
Brushed gold
Or brossé
Ouro escovado
Oro spazzolato



RG
Oro rosa cepillado
Brushed rose gold
Or rose brossé
Ouro rrosa escovado
Oro rosa spazzolato

Características / Features / Caractéristiques / Características / Caratteristiche



Tratamiento antical
Anti-limescale treatment
Traitement anti-calcaire
Tratamento anti-calcário
Trattamento anticalcare



Frontales a medida
Front doors made to measure
Frontales pivotantes sur mesure
Frontali personalizzati
Frontes personalizadas



Cristales especiales y serigrafías
Special glasses and screen lines
Verres spéciaux et sérigraphies
Cristalli speciali e serigrafie
Cristais e serigrafias especiais



Compensación total 1 cm
Total adjustment 1 cm
Compensation totale 1 cm
Regolazione totale 1 cm
Ajuste total 1 cm



Compensación sin tornillos
No screws adjustment
Adjustment sans vis
Nessuna regolazione viti
Compensação sem parafusos



Reversible
Reversible
Réversible
Reversível
Reversibile



Tapas cubre perfiles
Profile covers
Couvercles couvrant les profils
Cappucci copre profili
Caps cobre perfis



Barra de fijación
Support bar
Barre de fixation
Barra di fissaggio
Barra de fixaçã



Instalación rápida
Fast installation
Installation rapide
Installazione veloce
Instalação rápida



Fácil acceso
Easy acces
Accès facile
Facile accesso
Fácil acesso



Vidrio templado 8 mm
Tempered glass 8 mm
Verre trempé 8 mm
Vidro temperado 8mm
Vetro temperato 8 mm



Altura 200 cm
Height 200 cm
Hauteur 200 cm
Altezza 200 cm
Altura 200 cm

Opcional / Optional / Optionel / Opcional / Opzionale

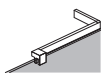

Barra paralela de fijación
Support paralel bar
Barra de fixation parallèle
Barra di fissaggio parallela
Barra de fixaçã paralela

● CR	MPACC006	● NB	MPACC017
● BM	MPACC010	● BG	MPACC018
● MG	MPACC016	● RG	MPACC019

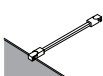

Barra de fijación extra max.100cm
Extra support bar max.100cm
Barre de fixation extra max.100cm
Barra di fissaggio extra max.100cm
Barra de fixaçã extra max.100cm

● CR	REMP00126	● NB	REMP00872
● BM	REMP00870	● BG	REMP00873
● MG	REMP00871	● RG	REMP00874

Medidas / Measures / Mesures / Medidas / Misure

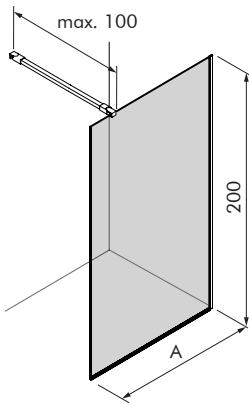

cm

dim.cm	ref.	A	P kg	P' kg	V cmxcmxcm
70	MP905070..	69-70	27	29	207x74,5x6,5
80	MP905080..	79-80	33	35	207x84,5x6,5
90	MP905090..	89-90	38	40	207x84,5x6,5
100	MP905100..	99-100	43	45	207x105x6,5
110	MP905110..	109-110	48	50	207x115x6,5
120	MP905120..	119-120	53	55,5	207x124x6,5
130	MP905130..	129-130	58	60,5	207x135x6,5
140	MP905140..	139-140	63	65,5	207x144x6,5

P: Peso neto / Net weight / Poids net / Peso líquido / Peso netto

P': Peso de expedición / Expedition Weight / Poids d'expédition / Peso do expedição / Peso spedizione

V: Volumen de expedición / Expedition Volume / Volume d'expédition / Volume do expedição / Volume spedizione

Perfil / Profile / Profil / Perfi / Profili

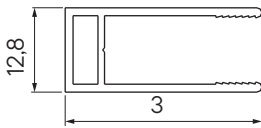

cm

Ala pivotante / Pivot wing / Aile pivotante / Ala pivottante / Asapivotante

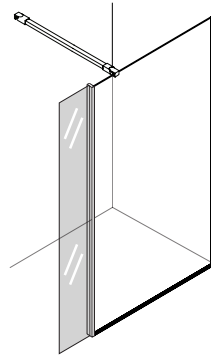

Acabados / Finishes / Finition / Acabamento / Finitura



CR
Cromado
Chromed
Chromé
Cromado
Cromato



BM
Negro mate
Black matt
Noir mat
Preto mate
Nero opaco



MG
Metal gun
Metal gun
Metal gun
Metal gun
Metal gun



NB
Niquel cepillado
Nickel brushed
Nickel brossé
Níquel escovado
Nichel spazzolato



BG
Oro cepillado
Brushed gold
Or brossé
Ouro escovado
Oro spazzolato



RG
Oro rosa cepillado
Brushed rose gold
Or rose brossé
Ouro rrosa escovado
Oro rosa spazzolato

Características / Features / Caractéristiques / Características / Caratteristiche



Tratamiento antical
Anti-limescale treatment
Traitement anti-calcaire
Tratamento anti-calcário
Trattamento anticalcare



Apertura 180°
Opening 180°
Ouverture à 180°
Apertura 180°
Abertura 180°



Cristales especiales y serigrafias
Special glasses and screen lines
Verres spéciaux et sérigraphies
Cristalli speciali e serigrafie
Cristais e serigrafias especiais



Sistema up & down
Up & down system
Système up & down
Sistema up & down
Sistema up & down



Altura 200 cm
Height 200 cm
Hauteur 200 cm
Altezza 200 cm
Altura 200 cm



Reversible
Reversible
Réversible
Reversível
Reversibile



Tapas cubre perfiles
Profile covers
Couvercles couvrant les profils
Cappucci copre profili
Caps cobre perfis



Barra de fijación
Support bar
Barre de fixation
Barra di fissaggio
Barra de fixação



Instalación rápida
Fast installation
Installation rapide
Installazione veloce
Instalação rápida



Fácil acceso
Easy acces
Accès facile
Facile accesso
Fácil acesso



Vidrio templado 8 mm
Tempered glass 8 mm
Verre trempé 8 mm
Vidro temperado 8mm
Vetro temperato 8 mm

Medidas / Measures / Mesures / Medidas / Misure

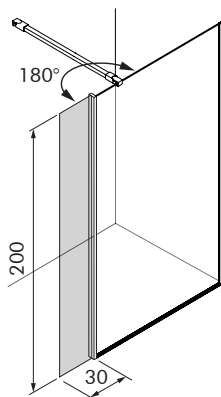

cm

dim.cm	ref.	P kg	P' kg	V cmxcmxcm
30	MP90530P..	13	15	207X34X6

P: Peso neto / Net weight / Poids net / Peso líquido / Peso netto

P': Peso de expedición / Expedition Weight / Poids d'expédition / Peso do expedição / Peso spedizione

V: Volumen de expedición / Expedition Volume / Volume d'expédition / Volume do expedição / Volume spedizione

Lateral / Side panel / Latéral / Lateral / Laterale

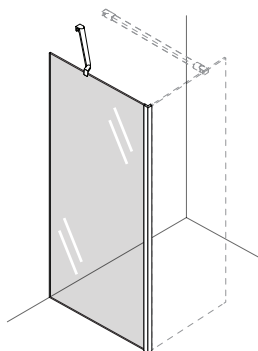

Acabados / Finishes / Finition / Acabamento / Finitura



CR
Cromado
Chromed
Chromé
Cromado
Cromato



BM
Negro mate
Black matt
Noir mat
Preto mate
Nero opaco



MG
Metal gun
Metal gun
Metal gun
Metal gun
Metal gun



NB
Níquel cepillado
Nickel brushed
Nickel brossé
Níquel escovado
Nichel spazzolato



BG
Oro cepillado
Brushed gold
Or brossé
Ouro escovado
Oro spazzolato



RG
Oro rosa cepillado
Brushed rose gold
Or rose brossé
Ouro rrosa escovado
Oro rosa spazzolato

Características / Features / Caractéristiques / Características / Caratteristiche



Tratamiento antical
Anti-limescale treatment
Traitement anti-calcaire
Tratamento anti-calcário
Trattamento anticalcare



Frontales a medida
Front doors made to measure
Frontales pivotantes sur mesure
Frontali personalizzati
Frentes personalizadas



Cristales especiales y serigrafías
Special glasses and screen lines
Verres spéciaux et sérigraphies
Cristalli speciali e serigrafie
Cristais e serigrafias especiais



Compensación total 1 cm
Total adjustment 1 cm
Compensation totale 1 cm
Regolazione totale 1 cm
Ajuste total 1 cm



Compensación sin tornillos
No screws adjustment
Adjustment sans vis
Nessuna regolazione viti
Compensação sem parafusos



Reversible
Reversible
Réversible
Reversível
Reversibile



Tapas cubre perfiles
Profile covers
Couvercles couvrant les profils
Cappucci copre profili
Caps cobre perfis



Barra de fijación
Support bar
Barre de fixation
Barra di fissaggio
Barra de fixaçõ



Instalación rápida
Fast installation
Installation rapide
Installazione veloce
Instalação rápida



Fácil acceso
Easy acces
Accès facile
Facile accesso
Fácil acesso



Vidrio templado 8 mm
Tempered glass 8 mm
Verre trempé 8 mm
Vidro temperado 8mm
Vetro temperato 8 mm



Altura 200 cm
Height 200 cm
Hauteur 200 cm
Altezza 200 cm
Altura 200 cm

Opcional / Optional / Optionel / Opcional / Opzionale

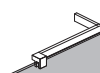

Barra paralela de fijación
Support paralel bar
Barra de fixation parallèle
Barra di fissaggio parallela
Barra de fixaçã paralela

● CR MPACC006 ● NB MPACC017
● BM MPACC010 ● BG MPACC018
● MG MPACC016 ● RG MPACC019

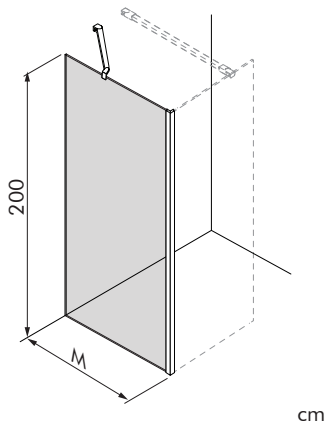

dim.cm	ref.	A	P kg	P' kg	V cmxcmxcm
60-70	MP91570..	M ± 0,5	27	29	208x76x9
70-80	MP91580..	M ± 0,5	33	35	208x86x9
80-90	MP91590..	M ± 0,5	38	40	208x96x9
90-100	MP915100..	M ± 0,5	43	45	208x106x9

M: Medida requerida en pedido / Measure required in order / Mesure spécifiée dans la commande / Tamanho requerido na encomenda / Dimensione richiesta all'ordine

P: Peso neto / Net weight / Poids net / Peso líquido / Peso netto

P': Peso de expedición / Expedition Weight / Poids d'expédition / Peso do expedição / Peso spedizione

V: Volumen de expedición / Expedition Volume / Volume d'expédition / Volume do expedição / Volume spedizione



sanysize

A la medida desde 60 a 100 cm
Made to measure from 60 to 100 cm
Sur mesure de 60 à 100 cm

Clear



Cristal transparente
Clear glass
Verre transparent
Cristal transparente
Cristallo trasparente

Clear Decor



Serigrafía Blanco sobre cristal transparente
Bianco silk-screen over clear glass
Bianco sérigraphie sur verre transparent
Bianco serigrafía sobre vidro transparente
Bianco serigrafato su vetro trasparente



Serigrafía Negro sobre cristal transparente
Nero silk-screen over clear glass
Nero sérigraphie sur verre transparent
Nero silk-screen sobre vidro transparente
Nero serigrafato su vetro trasparente



Decor Fabric 1 Bianco



Decor Fabric 2 Bianco



Decor Frame



Decor Orient

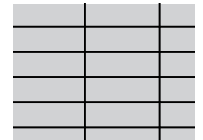

Decor Regular 1 Nero



Decor Dots 1 Bianco



Decor Dots 2 Bianco

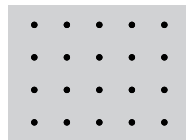

Decor Dots 1 Nero

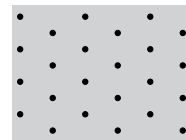

Decor Dots 2 Nero

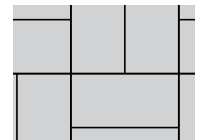

Decor Regular 2 Nero

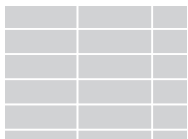

Decor Regular 1 Bianco

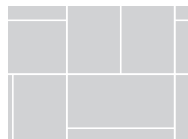

Decor Regular 2 Bianco

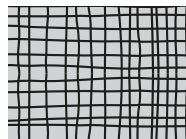

Decor Fabric 1 Nero



Decor Fabric 2 Nero

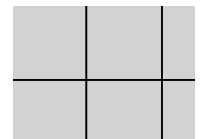

Decor Regular 3 Nero

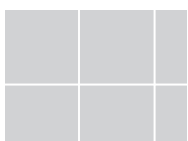

Decor Regular 3 Bianco



Decor Lines

Color



Ice, cristal mate
Ice, matt glass
Ice, verre matt
Ice, vidro mate
Ice, vetro matt



Cristal fumé
Fumé glass
Verre fumé
Vidrio fumé
Vetro fumé



Cristal fumé café
Coffee fumé glass
Verre fumé Café
Vidrio fumé café
Vetro fumé caffè

Premium



Cristal espejo
Mirror glass
Verre miroir
Vidro espelho
Vetro a specchio



Flute
Flute
Flute
Flute
Flute



Marque la opción deseada con una [x] y complete los campos requeridos.
 Mark the desired option with an [x] and complete the required fields.
 Cochez l'option souhaitée avec un [x] et remplissez les champs requis.
 Marcar a opção desejada com um [x] e preencher os campos requeridos.
 Contrassegnare l'opzione desiderata con una [x] e completare i campi richiesti.

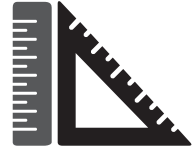

1

Indique el tipo de instalación que desea y especifique la dimensión M requerida / Indicate the type of installation desired and specify the required M dimension / Indiquez le type d'installation souhaité et spécifiez la dimension M requise / Indicar o tipo de instalação desejada e especificar a dimensão M necessária / Indicare il tipo di installazione desiderata e specificare la dimensione M richiesta

M: Medida requerida en pedido / Measure required in order / Mesure spécifiée dans la commande / Tamanho requerido na encomenda / Dimensione richiesta all'ordine

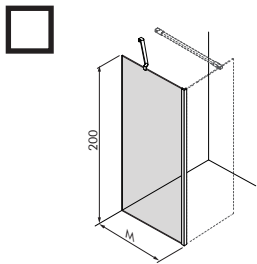

ref.	M
MP915	

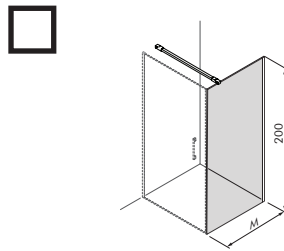

ref.	M
MP915	

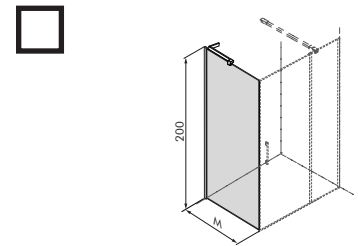

ref.	M
MP915	

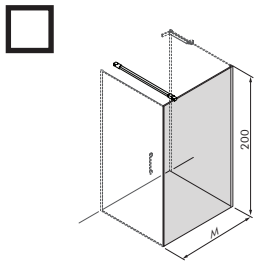

ref.	M
MP915	

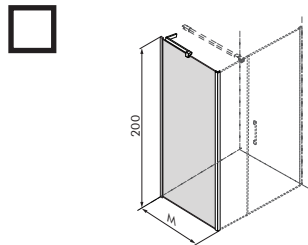

ref.	M
MP915	

2

Indique la dimensión del plato de ducha donde se instalará la *Single Side Panel* / Indicate the dimension of the shower tray where the *Single Side Panel* will be installed / Indiquez la dimension du receveur de douche où le *Single Side Panel* sera installé / Indicar a dimensão da base de duche onde será instalada a *Single Side Panel* / Indicare la dimensione del piatto doccia in cui verrà installato il *Single Side Panel*

3

Indique el tipo de instalación del plato de ducha / Indicate the type of shower tray installation / Indiquez le type d'installation du receveur de douche / Indicar o tipo de instalação da base de duche / Indicare il tipo di installazione del piatto doccia

Sobre el suelo / On the ground / Sur le sol / No solo / A terra

Encastrado / Embedded / Encasté / Embutido / Incastato

