

Bañera de encastre / Inset bathtub / Baignoire encastrée / Banheira incorporada / Vasca da bagno integrata
sanitaryacrylic



Acabados / Finishes / Finition / Acabamento / Finitura



WG

Blanco brillo
Gloss white
Blanc brillant
Branco brilho
Bianco lucido



Medidas / Measures / Mesures / Medidas / Misure

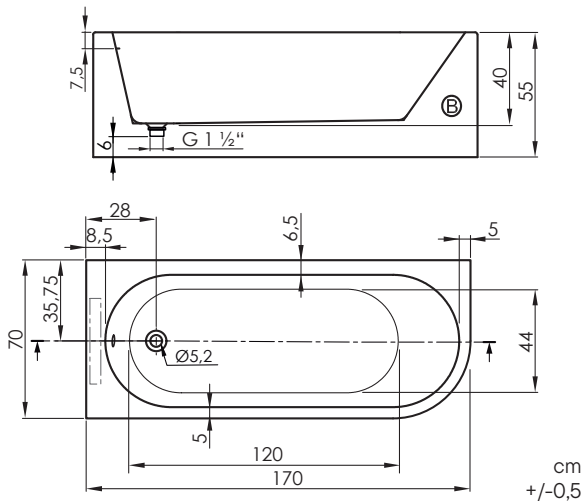

ref.	dim.	P kg	P' kg	V cmxcmxcm	CA L
BN142	170 x 70	47	55	177 x 77 x 61	182

P: Peso neto / Net weight / Poids net / Peso líquido / Peso netto

P': Peso de expedición / Expedition Weight / Poids d'expédition / Peso do expedição / Peso spedizione

V: Volumen de expedición / Expedition Volume / Volume d'expédition / Volume do expedição / Volume spedizione

CA: Contenido agua / Water content / Contenu d'eau / Conteúdo de água / Contenuto acqua

M Motor / Pump / Motore / Motor / Pompe

B Blower / Blower / Blower / Blower / Blower

Grifería / Taps / Robinets / Torneiras / Rubinetti



Loop



Loop K



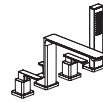

Kali

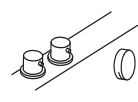
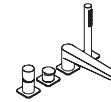

Cubo



 Posición habitual de la grifería
Usual tap position
Position commune du robinet
Posição usual da torneira
Posizione del rubinetto

 Posición habitual de la grifería Usual tap position
Position commune du robinet
Posição usual da torneira
Posizione del rubinetto

Incluído / Included / Inclus / Incluído / Incluso

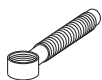

Tubo de descarga flexible, con codo
Flexible discharge tube, with elbow
Tube à décharge flexible, avec coude
Tubo de descarga flexível, com cotovelo
Tubo di scarico flessibile, con gomito



Desagüe click-clack cromado incluido
Chrome pop-up waste included
Bonde click-clack chromé inclus
Dreno click-clack cromado incluido
Scarico click-clack cromato incluso



Embellecedor rebosadero cromado
Chrome overflow trim
Garniture de trop-plein chromé
Acabamento de estouro do chrome
Troppopieno cromato

COMPONENTES / COMPONENTS / COMPOSANTS / COMPONENTES / COMPONENTI	EQUIPAMIENTO / EQUIPMENT / ÉQUIPEMENT / EQUIPAMENTO / EQUIPAGGIAMENTO				
	Confort	T Confort	B Confort	DS Confort	Elegance
Motor hidro / Pump / Pompe hydro/ Bomba hidráulica / Pompa					
Jets hidro / Jets hidro / Buses hydro/ Jatos hidro / Getto hidro					
Blower / Blower / Blower / Blower / Blower					●
Jets blower / Jets blower / Buses blower / Jatos blower / Getto blower					8
Focos cromoterapia LED / LED cromotherapy focus / Foyers chromothérapie LED / Focos cromoterapia LED / Foci cromoterapia LED					
Pulsador neumático / Pneumatic push / Commande pneumatique / Botão pneumático / Spinta pneumatica					
Regulador de aire / Air regulator / Variateur d'air manuel / Air regulador / Regulatore aria					
Pulsador on-off inox / On-off push inox / Commande on-off inox / Botão on-off inox / Spinta on-off inox					
Boca de aspiración / Suction mouth / Bouche de succion / Boca de aspiração / Bocca di aspirazione					
Panel táctil / Tactile panel / Panneau tactile / Painel táctil / Pannello tactile					●
Sensor de nivel / Sensor level / Détecteur de niveau / Sensor de nível / Sennsore di livello					●
Sistema autovaciado del blower / Self-emptying blower system / Système auto-vidange «blower» / Sistema auto-esvaziamento do blower / Sistema auto-svuotamento di blower					●
Peso kit / Kit weight / Poids kit / Peso kit / Peso kit (kg)					11
U (V)					230
F (Hz)					50
P (KW)					0,500
Nivel acústico / Acoustic level / Niveau sonore / Nível de som / Livello sonoro (dB)					52

SH



Elegance



Izquierda / Left / Gauche / Esquerda / Sinistra

Preinstalación / Preinstallation / Pré-installation / Pré-instalação / Preinstalacion

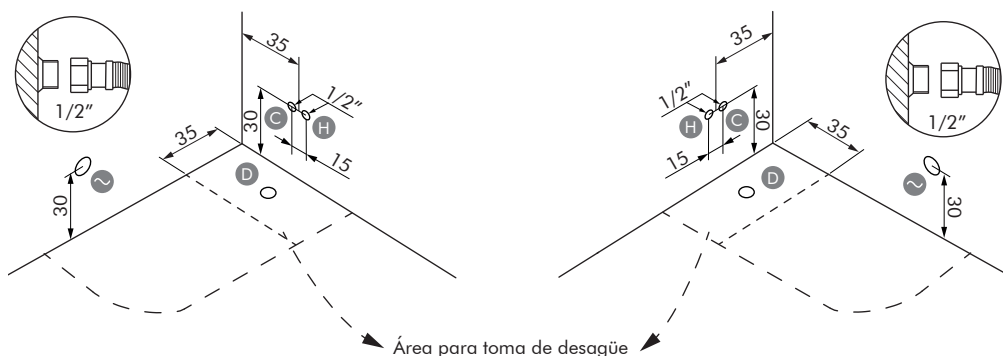

- D** Desagüe / Waste / Bonde / Drenagem / Scarico
- C** Agua fría / Cold water / Eau froide / Água fria / Acqua fredda
- H** Agua caliente / Hot water / Eau chaude / Água quente / Acqua calda
- S** Toma corriente / Power outlet / Prise électrique / Tomada eléctrica / Presa di corrente

www.sanycces.es