

Bañera de encastre / Inset bathtub / Baignoire encastrée / Banheira incorporada / Vasca da bagno integrata  
sanitaryacrylic



Acabados / Finishes / Finition / Acabamento / Finitura



WG  
Blanco brillo  
Gloss white  
Blanc brillant  
Branco brilho  
Bianco lucido

Medidas / Measures / Mesures / Medidas / Misure

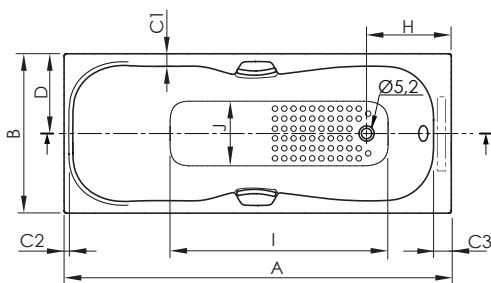
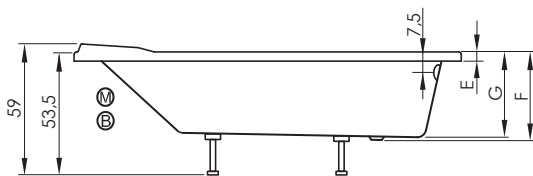

cm  
+/-0,5

- P: Peso neto / Net weight / Poids net / Peso líquido / Peso netto
- P': Peso de expedición / Expedition Weight / Poids d'expédition / Peso do expedição / Peso spedizione
- V: Volumen de expedición / Expedition Volume / Volume d'expédition / Volume do expedição / Volume spedizione
- CA: Contenido agua / Water content / Contenu d'eau / Conteúdo de água / Contenuto acqua

- Motor / Pump / Motore / Motor / Pompe
- Blower / Blower / Blower / Blower / Blower

ref.	dim.	A	B	C1	C2	C3	D	E	F	G	H	I	J	P kg	P' kg	V cmxcmxcm	CAL
BN132	170x70	170	70	7	3,5	8	35	4,5	40,5	38,5	27	117	38	17,5	20,5	185 x 75 x 50	149
BN132	180x80	180	80	7	3,5	8	40	4,5	40,5	38,5	27	127	45	24	27	195 x 85 x 50	185

Grifería / Taps / Robinets / Torneiras/ Rubinetti



Loop



Loop K



Kali

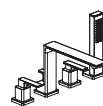

Cubo

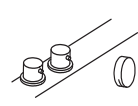
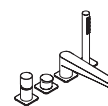

Posición habitual de la grifería  
Usual tap position  
Position commune du robinet  
Posição usual da torneira  
Posizione del rubinetto

Posición habitual de la grifería Usual tap position  
Position commune du robinet  
Posição usual da torneira  
Posizione del rubinetto

Preinstalación / Preinstallation / Pré-installation / Pré-instalação / Preinstalacion

A pared / To wall / À mur / A muro / A parete

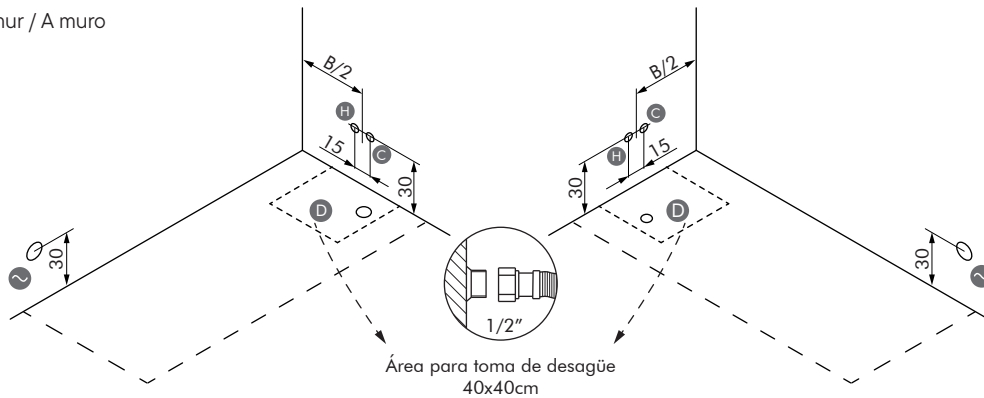

Encastre / Built-in / Encastrée / Encastré / Encastre

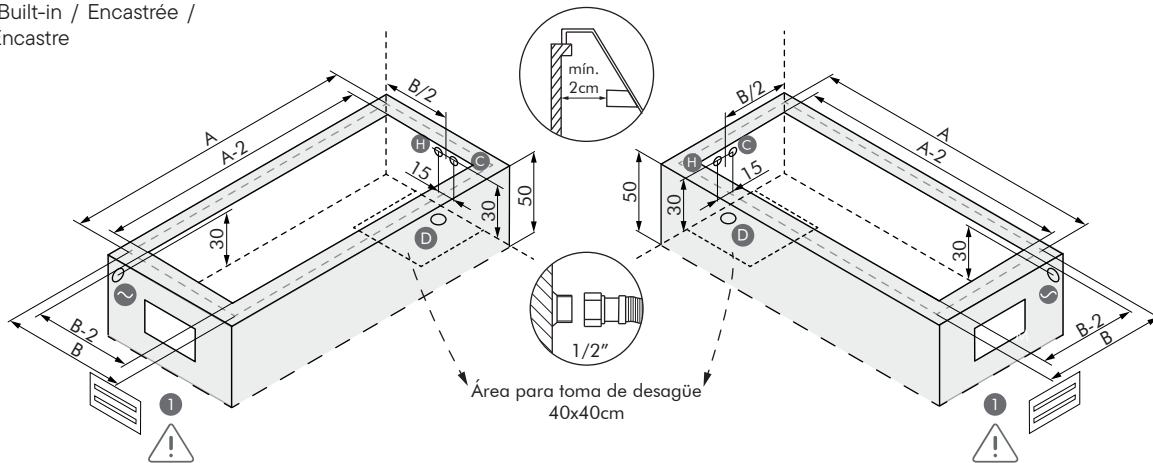

Exenta / Freestanding / En îlot / Freestanding / Centrostanza

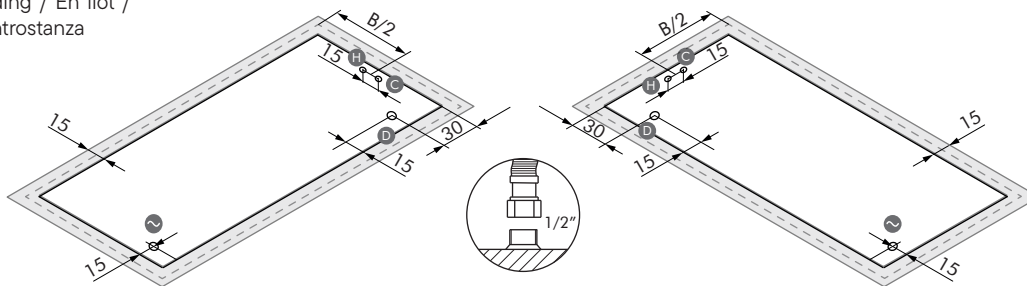

- D** Desagüe / Waste / Bonde / Drenagem / Scarico
- C** Agua fría / Cold water / Eau froide / Água fria / Acqua fredda
- H** Agua caliente / Hot water / Eau chaude / Água quente / Acqua calda
- ⚡** Toma corriente / Power outlet / Prise électrique / Tomada eléctrica / Presa di corrente

Área para grifería exenta / Area for freestanding tap / Zone pour robinet exemptés / Área para torneiras isentas / Area per rubinetti esenti

- ⚠ 1** Registro removible para ventilación, dimensión mínima 30x30cm. Para todas las bañeras con hidromasaje. Removable register for ventilation, minimum dimension 30x30cm. For all hydromassage bathtubs. Registre amovible pour ventilation, dimension minimum 30x30cm. Pour toutes les baignoires d'hydromassage. Registro removível para ventilação, dimensão mínima 30x30cm. Para todas as banheiras de hidromassagem. Registro smontabile per ventilazione, dimensione minima 30x30cm. Per tutte le vasche idromassaggio.

COMPONENTES / COMPONENTS / COMPOSANTS / COMPONENTES / COMPONENTI	EQUIPAMIENTO / EQUIPMENT / ÉQUIPEMENT / EQUIPAMENTO / EQUIPAGGIAMENTO				
	Confort	T Confort	B Confort	DS Confort	Elegance
Motor hidro / Pump / Pompe hydro/ Bomba hidráulica / Pompa	●	●		●	●
Jets hidro / Jets hidro / Buses hydro/ Jatos hidro / Getto hidro	6	6		6	10
Blower / Blower / Blower / Blower / Blower			●	●	●
Jets blower / Jets blower / Buses blower / Jatos blower / Getto blower			10	10	10
Focos cromoterapia LED / LED cromotherapy focus / Foyers chromothérapie LED / Focos cromoterapia LED / Foci cromoterapia LED					10
Pulsador neumático / Pneumatic push / Commande pneumatique / Botão pneumático / Spinta pneumatica	●				
Regulador de aire / Air regulator / Variateur d'air manuel / Air regulador / Regu- latore aria	●				
Pulsador on-off cristal / On-off push glass / Commande on-off cristal / Botão on-off do vidro / Spinta on-off cristal					●
Boca de aspiración / Suction mouth / Bouche de succion / Boca de aspiração / Bocca di aspirazione	●	●		●	●
Sensor de nivel / Sensor level / Détecteur de niveau / Sensor de nível / Senn- sore di livello		●	●	●	●
Sistema autovaciado del blower / Self-emptying blower system / Système auto-vidange «blower» / Sistema auto-esvaziamento do blower / Sistema au- to-svuotamento di blower			●	●	●
Peso kit / Kit weight / Poids kit / Peso kit / Peso kit (kg)	13	14	7,5	19	19
U (V)	230	230	230	230	230
F (Hz)	50	50	50	50	50
P (KW)	0,370	0,560	0,400	1,150	1,150
Nivel acústico / Acoustic level / Niveau sonore / Nível de som / Livello sonoro (dB)	49	49	52	52	52



SH



B Confort



Confort



DS Confort



T Confort



Elegance

Izquierda / Left / Gauche / Esquerda / Sinistra

Accesorios / Accessories / Accessoires / Acessórios / Accessori

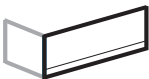
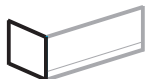
Paneles / Panels / Tabliers / Painéis / Pannelli	dim. cm	 Acrílico / Acrylic / Acrilique / Acrílico / Acrilico	H cm
* 	170	FALREC170	50
	180	FALREC180	50
* 	70	FALLAT70	50
	80	FALLAT80	50

\* Los faldones acrílicos permiten cubrir un máximo de tres lados, uno largo y dos cortos  
 Acrylic panels allow covering maximum three sides, one long side and two short sides  
 Les tabliers acryliques permettent la couverture sur trois côtés maximum, un côté long et deux côtés courts  
 Abas da tampa de acrílico permitem um máximo de três lados, um longo e dois curtos  
 Flaps copertura acrilica consentono un massimo di tre lati, uno lungo e due brevi