

Bañera de encastre / Inset bathtub / Baignoire encastrée / Banheira incorporada / Vasca da bagno integrata  
sanitaryacrylic



Acabados / Finishes / Finition / Acabamento / Finitura



WG

Blanco brillo  
Gloss white  
Blanc brillant  
Branco brilho  
Bianco lucido

Medidas / Measures / Mesures / Medidas / Misure

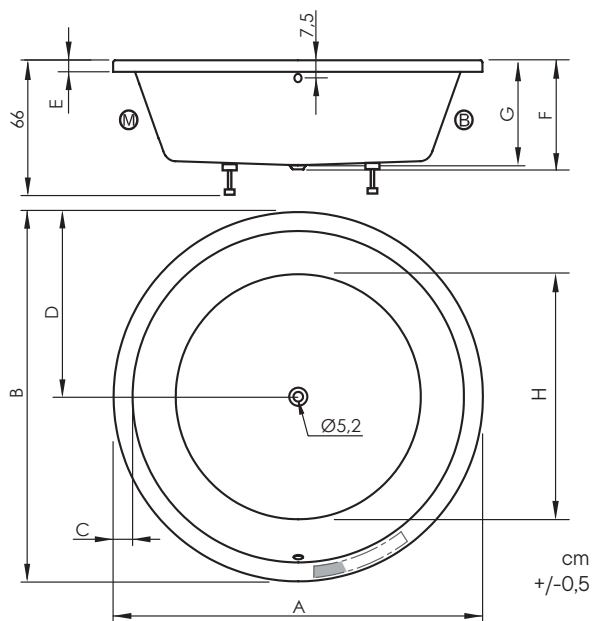

- P: Peso neto / Net weight / Poids net / Peso líquido / Peso netto
- P': Peso de expedición / Expedition Weight / Poids d'expédition / Peso do expedição / Peso spedizione
- V: Volumen de expedición / Expedition Volume / Volume d'expédition / Volume do expedição / Volume spedizione
- CA: Contenido agua / Water content / Contenu d'eau / Conteúdo de água / Contenuto acqua

- M** Motor / Pump / Motore / Motor / Pompe
- B** Blower / Blower / Blower / Blower / Blower

Esta bañera está ideada para llevar un faldón "freestanding", con entrada hidráulica y eléctrica inferior.  
This bath is designed to carry a "freestanding" panel, with lower water and power input.  
Cette baignoire est conçue pour porter un tablier "freestanding" avec une entrée hydraulique et électrique inférieure.  
Esta banheira é projetada para ser colocada com um painel "freestanding", com entrada baixa de água e energia.  
Questa vasca è stata progettata per essere collocata con un pannello "Freestanding", con ingresso d'acqua e elettricità inferiore.

| ref.  | dim. | A   | B   | C  | D  | E | F    | G  | H   | P kg | P' kg | V cmxcmxcm     | CA L  |
|-------|------|-----|-----|----|----|---|------|----|-----|------|-------|----------------|-------|
| BN155 | Ø160 | 160 | 160 | 10 | 80 | 5 | 52,5 | 50 | 100 | 46   | 48    | 161 x 161 x 54 | 411 L |
| BN155 | Ø180 | 180 | 180 | 10 | 90 | 5 | 52,5 | 50 | 120 | 58   | 60    | 181 x 181 x 54 | 563 L |
| BN155 | Ø190 | 190 | 190 | 10 | 95 | 5 | 52,5 | 50 | 130 | 65   | 67    | 191 x 191 x 54 | 647 L |

Medidas / Measures / Mesures / Medidas / Misure



Loop



Loop K



Kali

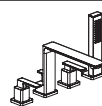

Cubo

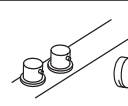
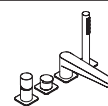

Posición habitual de la grifería  
Usual tap position  
Position commune du robinet  
Posição usual da torneira  
Posizione del rubinetto

Posición habitual de la grifería Usual tap position  
Position commune du robinet  
Posição usual da torneira  
Posizione del rubinetto

Preinstalación / Preinstallation / Pré-installation / Pré-instalação / Preinstalacion

Exenta / Freestanding / En îlot / Freestanding / Centrostanza

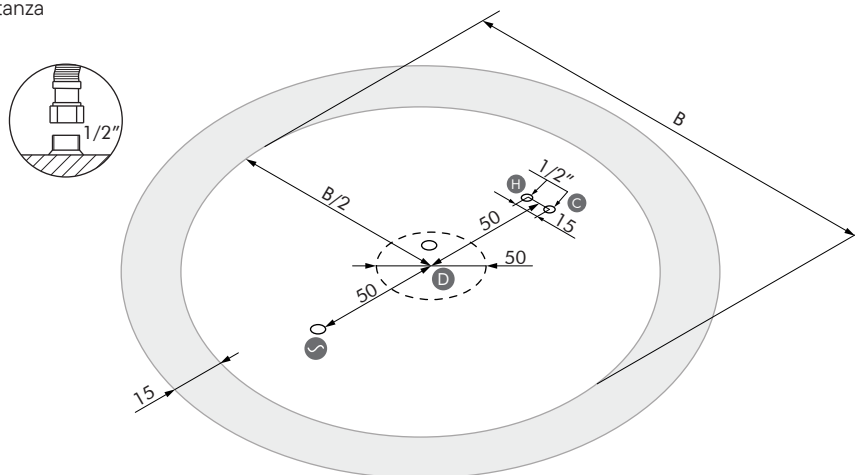

| dim.cm | B   |
|--------|-----|
| Ø160   | 160 |
| Ø180   | 180 |
| Ø190   | 190 |

Encastre / Built-in / Encastrée / Encastré / Encastre

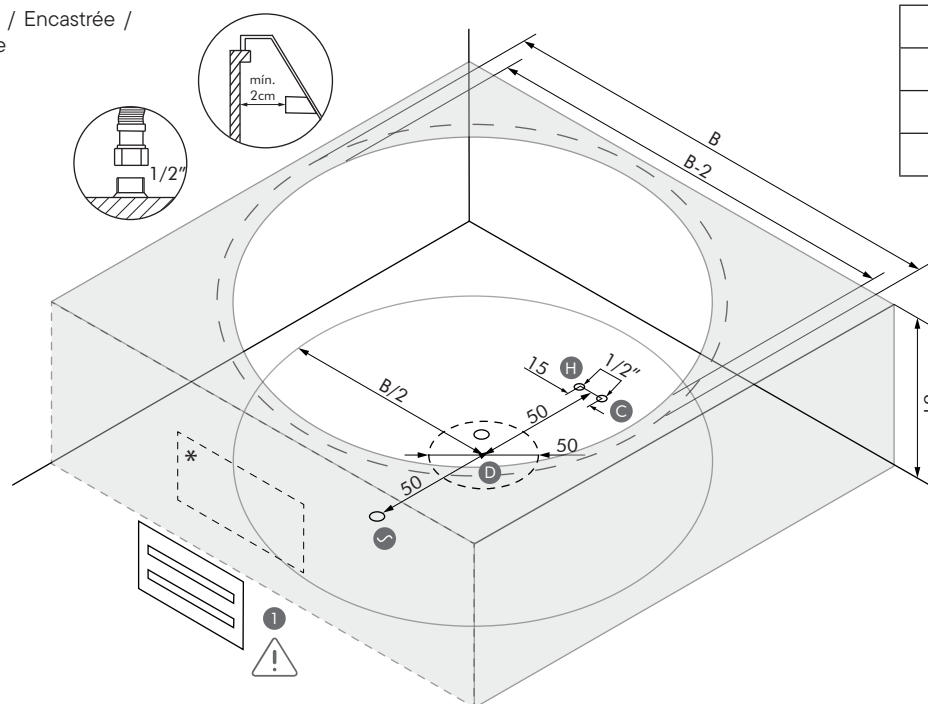

| dim.cm | B   |
|--------|-----|
| Ø160   | 160 |
| Ø180   | 180 |
| Ø190   | 190 |

- D** Desagüe / Waste / Bonde / Drenagem / Scarico
- C** Agua fría / Cold water / Eau froide / Água fria / Acqua fredda
- H** Agua caliente / Hot water / Eau chaude / Água quente / Acqua calda
- S** Toma corriente / Power outlet / Prise électrique / Tomada eléctrica / Presa di corrente

Área para grifería exenta / Area for freestanding tap / Zone pour robinet exemptés / Área para torneira isentas / Area per rubinetti esenti

- 1** Registro removible para ventilación, dimensión mínima 30x30cm. Para todas las bañeras con hidromasaje. Removable register for ventilation, minimum dimension 30x30cm. For all hydromassage bathtubs. Registre amovible pour ventilation, dimension minimum 30x30cm. Pour toutes les baignoires d'hydromassage. Registro removível para ventilação, dimensão mínima 30x30cm. Para todas as banheiras de hidromassagem. Registro smontabile per ventilazione, dimensione minima 30x30cm. Per tutte le vasche idromassaggio.

| COMPONENTES / COMPONENTS / COMPONENTS / COMPONENTES / COMPONENTI  | EQUIPAMIENTO / EQUIPMENT / ÉQUIPEMENT / EQUIPAMENTO / EQUIPAGGIAMENTO |                    |                    |                    |                    |
|---|---|--------------------|--------------------|--------------------|--------------------|
|   | Confort   | T Confort          | B Confort          | DS Confort         | Elegance           |
|   | Ø160 / Ø180 / Ø190  | Ø160 / Ø180 / Ø190 | Ø160 / Ø180 / Ø190 | Ø160 / Ø180 / Ø190 | Ø160 / Ø180 / Ø190 |
| Motor hidro / Pump / Pompe hydro/ Bomba hidráulica / Pompa  | ●   | ●                  |                    | ●                  | ●                  |
| Jets hidro / Jets hidro / Buses hydro/ Jatos hidro / Getto hidro  | 8 / 12 / 12   | 8 / 12 / 12        |                    | 8 / 12 / 12        | 12 / 12 / 12       |
| Blower / Blower / Blower / Blower / Blower  |   |                    | ●                  | ●                  | ●                  |
| Jets blower / Jets blower / Buses blower / Jatos blower / Getto blower  |   |                    | 8 / 12 / 12        | 8 / 12 / 12        | 12 / 24 / 24       |
| Focos cromoterapia LED / LED cromotherapy focus / Foyers chromothérapie LED / Focos cromoterapia LED / Foci cromoterapia LED  |   |                    |                    |                    | 12 / 12 / 12       |
| Pulsador neumático / Pneumatic push / Commande pneumatique / Botão pneumático / Spinta pneumatica   | ●   |                    |                    |                    |                    |
| Regulador de aire / Air regulator / Variateur d'air manuel / Air regulador / Regulatore aria  | ●   |                    |                    |                    |                    |
| Pulsador on-off cristal / On-off push glass / Commande on-off cristal / Botão on-off do vidro / Spinta on-off cristallo   |   |                    |                    |                    | ●                  |
| Boca de aspiración / Suction mouth / Bouche de succion / Boca de aspiração / Bocca di aspirazione   | ●   | ●                  |                    | ●                  | ●                  |
| Sensor de nivel / Sensor level / Détecteur de niveau / Sensor de nível / Sennsore di livello  |   | ●                  | ●                  | ●                  | ●                  |
| Sistema autovaciado del blower / Self-emptying blower system / Système auto-vidange «blower» / Sitema auto-esvaziamento do blower / Sitema auto-svuotamento di blower |   |                    | ●                  | ●                  | ●                  |
| Peso kit / Kit weight / Poids kit / Peso kit / Peso kit (kg)  | 13  | 14                 | 7,5                | 19                 | 19                 |
| U (V)   | 230   | 230                | 230                | 230                | 230                |
| F (Hz)  | 50  | 50                 | 50                 | 50                 | 50                 |
| P (KW)  | 560   | 560                | 900                | 1650               | 1650               |
| Nivel acústico / Acoustic level / Niveau sonore / Nivel de som / Livello sonoro (dB)  | 49  | 49                 | 52                 | 52                 | 52                 |

SH



B Confort



Confort



DS Confort







T Confort



Elegance



Accesorios / Accesories / Accesories / Acessórios / Accessori

| Faldón / Panel / Tablier /<br>Painéis / Pannelli                                     | dim. cm | <br>Acrílico / Acrylic / Acrilique / Acrílico / Acrilico | H cm | P kg | P' kg |
|--|---------|---|------|------|-------|
|  X2 | Ø160    | FAL155D160  | 61   | 10   | 12    |
|  X2 | Ø180    | FAL155D180  | 61   | 11   | 13    |
|  X2 | Ø190    | FAL155D190  | 61   | 12   | 14    |