

Bañera de encastre / Inset bathtub / Baignoire encastrée / Banheira incorporada / Vasca da bagno integrata  
sanitaryacrylic



Acabados / Finishes / Finition / Acabamento / Finitura



WG

Blanco brillo  
Gloss white  
Blanc brillant  
Branco brilho  
Bianco lucido

Medidas / Measures / Mesures / Medidas / Misure

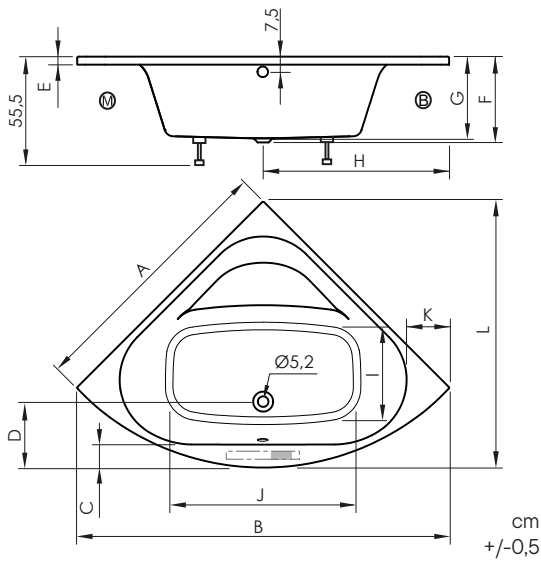

- P: Peso neto / Net weight / Poids net / Peso líquido / Peso netto
- P': Peso de expedición / Expedition Weight / Poids d'expédition / Peso do expedição / Peso spedizione
- V: Volumen de expedición / Expedition Volume / Volume d'expédition / Volume do expedição / Volume spedizione
- CA: Contenido agua / Water content / Contenu d'eau / Conteúdo de água / Conteno acqua

- M** Motor / Pump / Motore / Motor / Pompe
- B** Blower / Blower / Blower / Blower / Blower

ref.	dim.	A	B	C	D	E	F	G	H	I	J	K	L	P kg	P' kg	V cmxcmxcm	CA L
BN153	130x130	130	183	11	32,5	4	42,5	40	91,5	47	93	21	131	22	24	131x131x44	150
BN153	140x140	140	197	11	32,5	4	42,5	40	99	58	107	18,5	145	26	28	141x141x44	200
BN153	150x150	150	212	11	32,5	4	42,5	40	106	67	121	20	159	32,3	34,5	151x151x44	246
BN153	160x160	160	226	11	32,5	4	42,5	40	113	76	136	19	173	37,8	40	161x161x44	301

Grifería / Taps / Robinets / Torneiras/ Rubinetti



Loop



Loop K



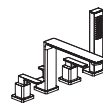

Kali

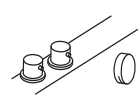
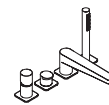

Cubo



 Posición habitual de la grifería  
Usual tap position  
Position commune du robinet  
Posição usual da torneira  
Posizione del rubinetto

 Posición habitual de la grifería Usual tap position  
Usual tap position  
Position commune du robinet  
Posição usual da torneira  
Posizione del rubinetto

Preinstalación / Preinstallation / Pré-installation / Pré-instalação / Preinstalacion

Con faldón / With panel / Avec tablier / Com painéis / Con pannelli

dim.cm	A	Ø
130x130	130	55
140x140	140	55
150x150	150	55
160x160	160	55

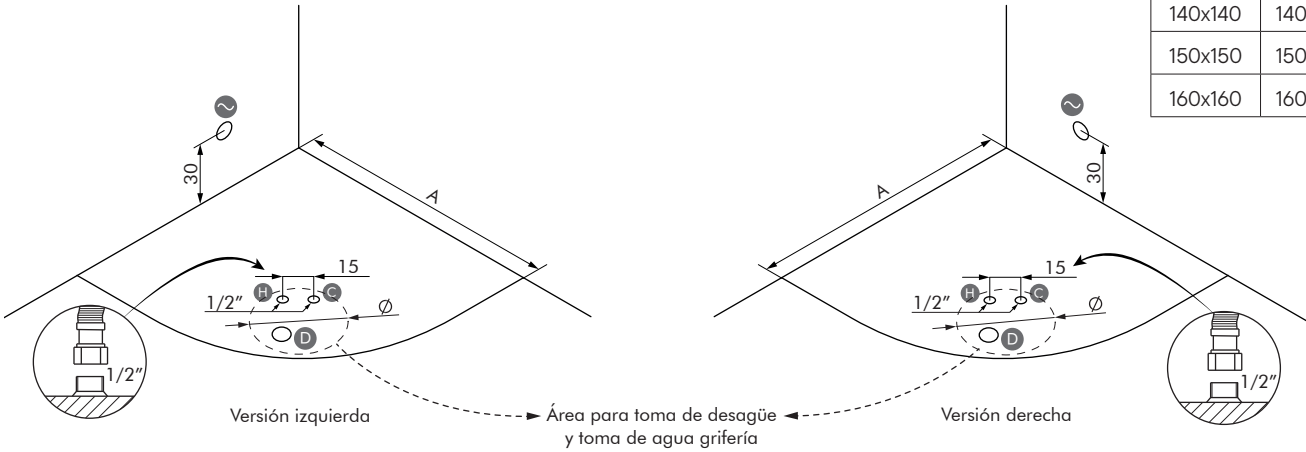

Con murete de obra / With masonry wall / Avec mur de maçonnerie / Com parede de alvenaria / Con muro in muratura

dim.cm	A	Ø
130x130	130	55
140x140	140	55
150x150	150	55
160x160	160	55

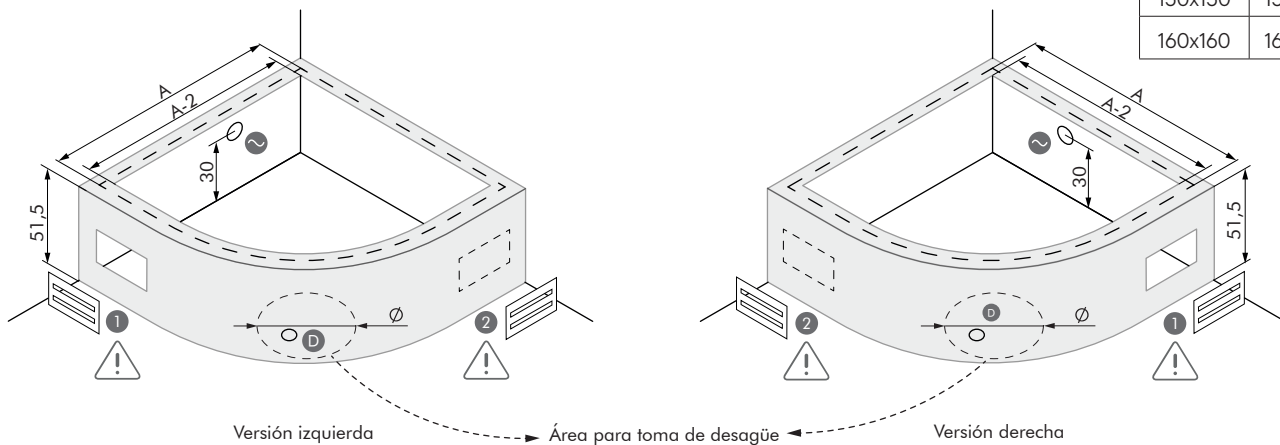



- D** Desagüe / Waste / Bonde / Drenagem / Scarico
- C** Agua fría / Cold water / Eau froide / Água fria / Acqua fredda
- H** Agua caliente / Hot water / Eau chaude / Água quente / Acqua calda
- ~** Toma corriente / Power outlet / Prise électrique / Tomada eléctrica / Presa di corrente

Área para grifería exenta / Area for freestanding tap / Zone pour robinet exemptés / Área para torneira isentas / Area per rubinetti esenti

- 1** Registro removible para ventilación, dimensión mínima 30x30cm. Para todas las bañeras con hidromasaje. Removable register for ventilation, minimum dimension 30x30cm. For all hydromassage bathtubs. Registre amovible pour ventilation, dimension minimum 30x30cm. Pour toutes les baignoires d'hydromassage. Registro removível para ventilação, dimensão mínima 30x30cm. Para todas as banheiras de hidromassagem. Registro smontabile per ventilazione, dimensione minima 30x30cm. Per tutte le vasche idromassaggio.
- 2** Registro removible para ventilación adicional, dimensión mínima 30x30cm. Para bañeras con Blower, salvo sistema B confort. Removable register for additional ventilation, minimum dimension 30x30cm. For bathtubs with Blower, except B comfort system. Registre amovible pour aération supplémentaire, dimension minimum 30x30cm. Pour baignoires avec Blower, sauf système B confort. Registro removível para ventilação adicional, dimensão mínima 30x30cm. Para banheiras com Blower, exceto sistema B de conforto. Registro smontabile per ventilazione supplementare, dimensione minima 30x30cm. Per vasche con Blower, escluso sistema comfort B.

COMPONENTES / COMPONENTS / COMPO-SANTS / COMPONENTES / COMPONENTI	EQUIPAMIENTO EQUIPMENT / ÉQUIPEMENT / EQUIPAMENTO / EQUIPAGGIAMENTO				
	Confort	T Confort	B Confort	DS Confort	Elegance
	130 / 140 / 150 / 160	130 / 140 / 150 / 160	130 / 140 / 150 / 160	130 / 140 / 150 / 160	130 / 140 / 150 / 160
Motor hidro / Pump / Pompe hydro/ Bomba hidráulica / Pompa	●	●		●	●
Jets hidro / Jets hidro / Buses hydro/ Jatos hidro / Getto hidro	6 / 6 / 6 / 6	6 / 6 / 6 / 6		6 / 6 / 6 / 6	6 / 6 / 10 / 10
Blower / Blower / Blower / Blower / Blower			●	●	●
Jets blower / Jets blower / Buses blower / Jatos blower / Getto blower			9 / 10 / 10 / 10	9 / 10 / 10 / 10	9 / 10 / 14 / 14
Focos cromoterapia LED / LED cromotherapy focus / Foyers chromothérapie LED / Focos cromoterapia LED / Foci cromoterapia LED					6 / 6 / 10 / 10
Pulsador neumático / Pneumatic push / Commande pneumatique / Botão pneumático / Spinta pneumatica	●				
Regulador de aire / Air regulator / Variateur d'air manuel / Air regulador / Regulatore aria	●				
Pulsador on-off cristal / On-off push glass / Commande on-off cristal / Botão on-off do vidro / Spinta on-off cristallo					●
Boca de aspiración / Suction mouth / Bouche de succion / Boca de aspiração / Bocca di aspirazione	●	●		●	●
Sensor de nivel / Sensor level / Détecteur de niveau / Sensor de nível / Sensore di livello		●	●	●	●
Sistema autovaciado del blower / Self-emptying blower system / Système auto-vidange «blower» / Sistema auto-esvaziamento do blower / Sistema auto-svuotamento di blower			●	●	●
Peso kit / Kit weight / Poids kit / Peso kit / Peso kit (kg)	13	14	7,5	19	19
U (V)	230	230	230	230	230
F (Hz)	50	50	50	50	50
P (W)	370 / 370 / 560 / 560	560 / 560 / 560 / 560	500 / 500 / 900 / 900	1250 / 1250 / 1650 / 1650	1250 / 1250 / 1650 / 1650
Nivel acústico / Acoustic level / Niveau sonore / Nivel de som / Livello sonoro (dB)	49	49	52	52	52

Accesorios / Accesproes / Accessories / Acessórios / Accessori

Faldón / Panel / Tablier / Painéis / Pannelli	dim. cm	 Acrílico / Acrylic / Acrilique / Acrílico / Acrílico	H cm	Peso Neto Kg
	130x130	FAL153130	51	3,5
	140x140	FAL153140	51	4
	150x150	FAL153150	51	4
	160x160	FAL153160	51	4,5

SH



B Confort



Confort



DS Confort



T Confort



Elegance



Izquierda / Left / Gauche / Esquerda / Sinistra

[www.sanycces.es](http://www.sanycces.es)