





Monomando ducha mural horizontal de 2 vías / Wall-mounted shower mixer 2 ways / Mitigeur de douche mural 2 voies

Acabados / Finishes / Finition / Acabamento / Finitura

| | | |
|--|---|--|
|  Cromado Chromed Chromé Cromado Cromato |  Negro mate Black matt Noir mat Preto mate Nero opaco |  Metal gun Metal gun Metal gun Metal gun Metal gun |
|  Níquel cepillado Nickel brushed Nickel brossé Níquel escovado Nichel spazzolato |  Oro cepillado Brushed gold Or brossé Ouro escovado Oro spazzolato |  Oro rosa cepillado Brushed rose gold Or rose brossé Ouro rosa escovado Oro rosa spazzolato |
| CR | BM | MG |
| NB | BG | RG |



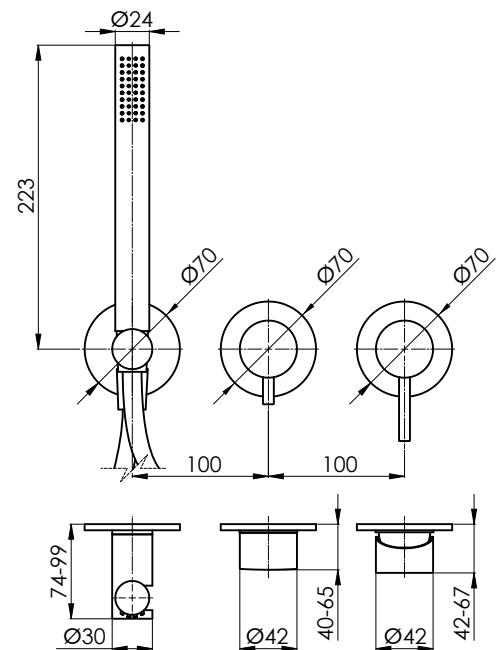

Características / Features / Caractéristiques / Características / Caratteristiche

| | |
|---|---|
|  Monomando Mixer Mitigeur Torneira Monocomando |  2 vías 2 ways 2 voies 2 caminhos 2 vie |
|  Teleducha de latón Brass handshower Douchette à main en laiton Chuveiro de mão de latão Doccetta in ottone |  Flexo 1,5m 1,5 m hose Flexible 1,5m Manguera de chuveiro 1,5m Flessibile 1,5m |
|  Flexo Silicona Silicone hose Flexible Silicone Manguera de chuveiro Silicone Flessibile Silicone | |

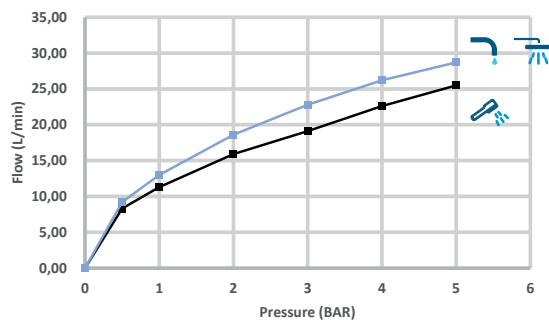

Caudal / Flow rate / Débit / Fluxo / Flusso



| Pressure (BAR) | 0 | 0,5 | 1 | 2 | 3 | 4 | 5 |
|---|---|-----|------|------|------|------|------|
| Flow rate (l/min)  | 0 | 8,3 | 11,3 | 15,9 | 19,1 | 22,6 | 25,5 |
| Flow rate (l/min)  | 0 | 9,2 | 13 | 18,6 | 22,8 | 26,2 | 28,7 |

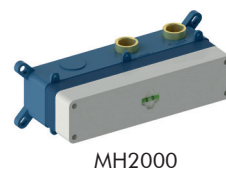

Debe acompañarse con el cuerpo de empotrar **sanybox** correspondiente.
Must be accompanied by the corresponding concealed body **sanybox**.
Doit être accompagnée du corps encastré **sanybox** correspondant.
Deve ser acompanhado com o corpo de incorporação **sanybox** correspondente.
Deve essere accompagnato dal corpo da incasso **sanybox** corrispondente.

| ref. | P kg | P' kg | V cmxcmxcm |
|-----------|------|-------|-------------|
| MH2D001.. | 1,10 | 1,33 | 30,3x13,8x7 |

P: Peso neto / Net weight / Poids net / Peso líquido / Peso netto

P': Peso de expedición / Expedition Weight / Poids d'expédition / Peso do expedição / Peso spedizione

V: Volumen de expedición / Expedition Volume / Volume d'expédition / Volume do expedição / Volume spedizione